

**Article Info**

Received: 25 Jan 2016 | Revised Submission: 20 Feb 2016 | Accepted: 28 Feb 2016 | Available online: 15 Mar 2016

**Modeling and Microstructure Study of Thermally Evaporated Nano Film Thickness of Gold**

*Shailendra Kumar Gaur\* and R. S. Mishra\*\**

**ABSTRACT**

*The paper represents the modeling of nano scale gold film thickness deposited by thermal evaporation process. Gold is evaporated from a resistively heated boat at a temperature of 1900 K onto a surface held on a fixed surface. The incident molecular flux onto the silicon surface is  $7.86 \times 10^{19}$  (1/m<sup>2</sup>sec). The thickness varies between 78 nm and 80 nm across the sample after 60 s of deposition, with radial symmetry about the midpoint of the source. The film thickness, mass deposited on the substrate and mass transfer rate on silicon substrates with time dependent model using BDF solver is calculated. The SEM micrographs shows the smooth and uniformly distributed nano scale gold film on silicon and the average grain size of gold is 15-30 nm. The XRD analysis shows the polycrystalline face centered cubic (fcc) structure in preferential (111) plane. Deposited gold film thickness measured from Dektak surface profiler at different points on the substrate surface.*

**Keywords:** *Physical Vapor Deposition; Modeling; Film Thickness Simulation; Thin Film Deposition; Vacuum.*

**1.0 Introduction**

PVD is used for metals while dielectrics can be deposited using specialized equipments. It rely on thermal energy supplied to the crucible or boat to evaporate atoms. Evaporated atoms travel through the evacuated space between the source and the sample and stick to the sample. Few, if any, chemical reactions occur due to low pressure can force a reaction by flowing a gas near the crucible. Physical methods produce the atoms that deposit on the substrate by evaporation and sputtering. Sometimes called vacuum deposition because the process is usually done in an evacuated chamber Surface reactions usually occur very rapidly and there is very little rearrangement of the surface atoms after sticking. Thickness uniformity and shadowing by surface topography, and step coverage are issues. Ali Moarrefzadeh et al. [1] discussed that Physical vapor deposition (PVD) includes a wide range of vacuum coating processes in which material is physically taken out from a source by evaporation or sputtering, transported through a vacuum or partial vacuum by the energy of the vapor particles, and condensed as a film on the surfaces of appropriately placed parts or

substrates. A group of very versatile coating processes in which a material is converted to its vapor phases in a vacuum chamber and condensed onto a substrate surface as a very thin film (upto 1  $\mu$ m thickness).

The deposition of thin film layers from the vapor phase is done through several methods. We study and analyze the physical vapor deposition (PVD) techniques and equipments that are in common use in the large scale production of coatings that find uses in the optical, display, decorative, tribological, and energy-generating /saving industries. Evaporating materials are classified as dielectric compounds, metals, alloys, or mixtures.

The same evaporant material can exhibit different optical, electrical, and mechanical properties depending on the deposition process. Titanium oxide is a unique example of a metal oxide compound that, depending on deposition process parameters, can be made into film layers that are: transparent, electrically conductive, chemically reactive to light and bio- agents, chemically inert, or exhibit spectrally selectively absorption. The dependent parameters are starting composition, oxidation state, and crystalline

\*Department of Mechanical Engineering, Delhi Technological University, Delhi, India

\*\*Corresponding Author: Department of Mechanical Engineering, Delhi Technological University, Delhi, India  
(E-mail: professor\_rsmishra@yahoo.co.in)

structure and packing density. PVD techniques used generally are basically two in nature: thermal evaporation by resistively heating or by using an electron- beam heating, and sputtering, a no thermal process. P.S.Raghupathi et.al. [2] and Haichuan Mu et.al. [3] discussed that the thermal evaporation deposition rate influence the structural, electrical & optical properties of thin film deposited like in case of Indium-tin-oxide(ITO).Alterations and accompaniments are made to the basic PVD techniques to permit different coating materials and substrate types to be included additions designed to alter the growth nano-structure or composition of the film through control of the dependent variables listed above include bombardment of the growing film by high energy inert- or and reactive ions, substrate heating, atmosphere composition and partial pressure, rate, and vapor incidence angle.

## 2.0 Literature Review

The nanoscale gold film thickness has found newer capabilities in different fields of science & technology such as coating glasses/mica to change their properties and many coloured optical coding for biological assays. Gold nanometer thick film is being used to enhance electro luminescence and quantum efficiency in light emitting diodes. Besides signal amplification, nanometer thick gold film evolved new types of new sensors that are capable of detecting very small amounts of analyses such as chemical vapors in the scale of few ppm. Adeleh Granmayeh Rad et al [4] discussed the usage of gold nano film is in making advanced dyes and pigments. Sometimes gold nano film has been used to dye textiles, support to supply clean energy (by solar cell) and high density data storage (flash memories and discs). Gold nanoscale film quality of non- toxic and biocompatibility both in vivo and in vitro environments makes useful in bio-medical applications.

The unique properties of gold nanoscale structured materials supply good opportunity for coordinating biological identification events with electronic signal transduction and for making an evolution of bioelectronics devices with newer features. Gold in nanoscales have been found for

potential candidates to support in photo-thermal therapy and radiotherapy. Optical and electronic properties of gold can be utilized to improve the contrast in molecular imaging for the detection of cancer initially. Gold-based technologies also help to facilitate a ultimate needle-free delivery system, a technique that used gold and permitted vaccines to be supplied through the skin producing use of the fact that small particles can go through gaps between cells while large ones cannot. Gold nanoscale- based technologies give solution to some of environmentally great issues, such as ecofriendly production methods, pollution control and water purification. No doubt gold is really one of the non- reactive metals, and it is resistant to oxidation. Ragini Raj Singh et al. [5 ] discussed gold is also used in Photovoltaic HgCdTe Mid wavelength Infra-red detector to make ohmic contacts to find out the passivation characteristics of CdS/HgCdTe structure using C-V measurements. Wenjun Zhou et.al [6] discussed the Chemical vapour deposition (CVD) generally uses a gas-phase precursor, often a halide or hydride of the element to be deposited. In the case of MOCVD, an organometallic gas is used. Commercial techniques often use very low pressures of precursor gas. The chamber is first evacuated to a vacuum of around 5m torr and substrate temperature fixed to 350°C. Now evaporator is resistively heated to a temperature of about 160°C to start volatilization of the precursor. The deposited precursor then thermally decomposes into pure gold by a reaction above 300°C. The thickness of the gold film can be controlled by adjusting the amount of precursor, the temperature of the deposition chamber, and the location of the samples to be coated relative to the inlet of the evaporator into the deposition chamber. Generally gold precursor is thermally stable between 150 and 300 °C. Keewah Chan et al [7] discussed that gold can be deposited on silicon or quartz by rf sputtering by using DC sputter coating system. The rf power can of several hundred watt, substrate temperature about 300 °C with a vacuum of 1mbar order or better for time depending upon the thickness required, say for nanometer thickness 1 hour. Carl E. Larson et al. [8] discussed that gold deposition of high purity gold onto various substrates from dimethyl-2fl- pentandionato gold (III), Me<sub>2</sub>Au (acac), by localized, laser- induced

(photothermal) chemical vapor deposition. CVD of gold from dimethyl - (1,1, 1 - trifluoro - 2, 4 - pentandionato) gold (III) and dimethyl-(1,1,1,5,5,5-hexafluoro-2,4-pentandionato) gold(III),  $\text{Me}_2\text{Au}$  (tfac) and  $\text{Me}_2\text{Au}$ (hfac) complex can be done in a stainless steel vacuum chamber evacuated by a turbomolecular/diffusion/cryo pump to a base pressure of  $< 10^{-6}$  torr. A flow of argon or nitrogen carrier gas through a Pyrex vessel containing the gold complex at room temperature is used to deliver the organogold precursor into the chamber through stainless steel lines. Chamber vacuum and carrier gas flow rate could be varied independently. Deposition proceeds on a substrate placed in the chamber in the flow path of the carrier gas and heated by a copper block heater with temperature controller. Miroslav Gojo et al [9] discussed that gold can be deposited in a thermostatically controlled electrode cells in a electrodeposition Cell has two openings, one for thermometer another for nitrogen inlet for purging the oxygen out of the electrolyte keeping pH value 5 to 7 and each silicon wafer piece coated and alloyed with gold as working electrode, filled with chosen electrolyte warmed upto a given temperature and purged with nitrogen. Gold deposited by electrochemical method has higher purity, lower permeability and good adhesion to the substrate. Anne-Felicie Lamic-Humblot et al[10] discussed that gold can be very easily deposited at ambient pressure and in distilled water with magnetic rod stirring, followed by thermal treatment from tetrachloroauric acid and urea. T. Donnelly et.al.[11] discussed that gold on nano scale can be deposited on Si and sapphire by pulse laser deposition(PLD) by Nd : laser operating at 1064, 20Hz and pulse length of 6 nano sec used in a vacuum. The PLD deposited gold nano scale film is characterized and below 5 nm equivalent thickness AFM confirms the nano particles while optical measurement shows surface plasmon resonance shifts to longer wavelengths with increasing thickness. X.Zhang et.al.[12] discussed that gold film deposited on a quartz crystal ablated by excimer laser and found that ablation rate is more than two order higher than surface vaporization model prediction. Also this ablation rate strictly dependent on gas pressure. Anna Schaub et.al [13] discussed that gold deposited by

vacuum evaporation on glass substrate without heating glass and with heated glass. Further characterization is done of those deposited films i.e. without heated glass, without heated glass followed by annealing at 300 °C and heated glass, finding that heating during evaporation results in decrease in roughness and morphology changes with heating and annealing conditions. Behrang Moazzez et.al.[14] stated that the good adhesion gold on electronic device such as sensors, MEMS etc. making surface can be improved by applying gold deposition step on SU-8 photo resist prior to UV exposure but after the pre-bake step of SU-8 processing. Maxime Gougis et al. [15] discussed the gold deposition by pulse laser ablation on carbon nano-tube electrode but with in presence of oxygen and confirmed the non oxide formation by characterization. C. Celedón et.al.[ 16 ] discussed that the surface roughness affects on the energy straggling associated to the energy loss distributions of protons transmitted through a self supported metallic thin foil. Hartmann Hieber and Karin Pape [17] discussed the ageing of gold stating that degradation under thermal and electrical fault and in contaminated conditions is very low that is why gold is better than other metallization. Adam Proszynski et al [18] discussed that stress is developed during vacuum evaporation of gold nanometer film which can be reduced by post annealing process and further characterized the film for confirmation. Thin tin oxide deposited surface is very useful in industries due to their properties such as n-type Semi-conductor character, high optical transmission in visible range, high reflectivity; in the infra-red as well as good chemical resistance. Thus they can be used to form transparent and chemically stable thermal barriers.

### 3.0 Research Gap Identified

A lot of research work has been done on the evolution of gold film deposited on nanoscale or higher thickness by different deposition process through different heating sources (resistively, sputtering, E-beam, magnetron, radio frequency) in different baskets/crucibles at different temperatures and modeled mostly with direct simulation monte carlo. Also these methods solve in the volumes of the modeled and geometries. Number densities

found to be not accurate and precise. Ineligible simulation for the accurate modeling of low pressure, low velocity gas flows in complex geometries. These studies subjected to statistical scatter. Moreover, these could not completely explained free molecular flow interface and applied direct simulation monte carlo (dsmc) computes the trajectories of large numbers of randomized particles through the system, but introduces statistical noise to the modeling process and also the method is slower. Moreover, present work emphasis on the thermal and mass transfer of thermal evaporation process as well as structural analysis of deposited thin films leading to better optimization of thermal evaporation process and development of suitable electronic device fabrication applications.

#### 4.0 Experimental Details

Generally during thermal evaporation of gold island films were prepared using a laboratory thermal evaporation setup as shown in Figure 1 working at residual vacuum of  $(2.5 - 4) \times 10^{-6}$  mbar.

The deposition setup was equipped with the two-stage vacuum system based on the diffusion pump (oil based), turbomolecular or cryopump along with rotary vane pump or rotary screw pump (oil free). In case of oil based pumps the ultimate vacuum achieved in the system depends upon the vapor pressure of the oil used in pumps, generally Silicone based oils are used to achieve vacuum of  $1.0 \times 10^{-6}$  or higher order in the chamber.

Thermal evaporation system consists of multi turret to resistively heat molybdenum boat or tungsten filament/basket into source material (gold, tin or indium) is kept, radiant heater, quartz crystal assembly.

To measure the film thickness during process as well as rate of deposition, it consists of digital thickness monitor (DTM) which is basically a piezoelectric transducer. It consists of quartz crystal of standard 6MHz frequency with crystal assembly and digital monitor. This frequency of crystal decreases with damped oscillation during deposition with time and for this crystal oscillator is attached with crystal assembly as shown in Fig

ure 3.3. This quartz crystal needs regular cleaning with certain chemical depending upon the evaporant (source) material. Further this thickness of deposited film can be measured with dektek surface profilometer.

To measure the rotary pump and turbo molecular pump vacuum thermal evaporation system consists of pirani gauge and penning gauge with gauge head. For initial pre-heating of source material (gold) to remove oxides etc a source shutter is provided in the system. A liquid nitrogen trap is provided inside the thermal evaporation of system to get more fine and fast vacuum in the system as well as acts as a barrier in oil diffusion pump for hot oil vapor not going into the vacuum chamber.

Sometimes high discharge Ar gas plasma substrate cleaning can be done at vacuum of  $5 \times 10^{-3}$  mbar, if needed. The films were deposited on the silicon substrates cleaned in the ultrasound bath in isopropyl alcohol and drained by a compressed air flux. During the deposition, all substrates were kept at room temperature i.e no substrate heating or cooling. Gold film evaporated at residual vacuum from tungsten filament/molybdenum boat at temperature of  $2000^{\circ}\text{K}$

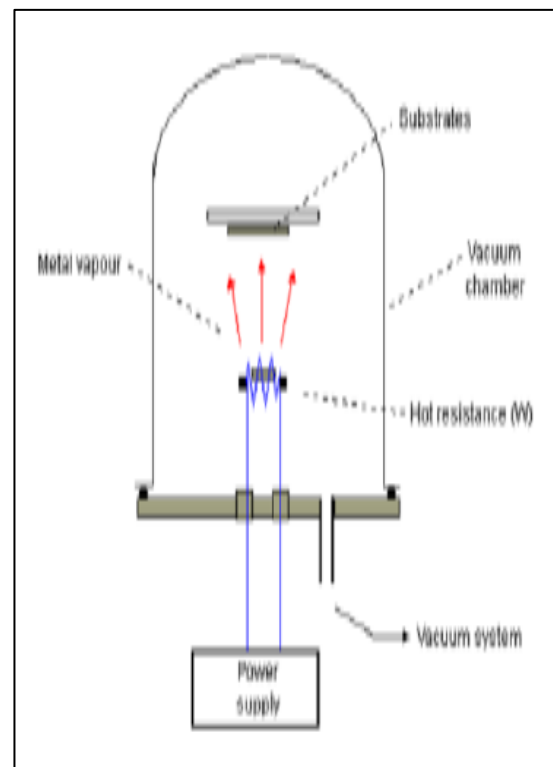

Vapor pressure varies depending upon the source temperature and is different for different materials, for suitability standard plot [31] is provided from which depending upon source material vapor pressure is selected.

**Fig 2: Vacuum Coating Process Diagram**

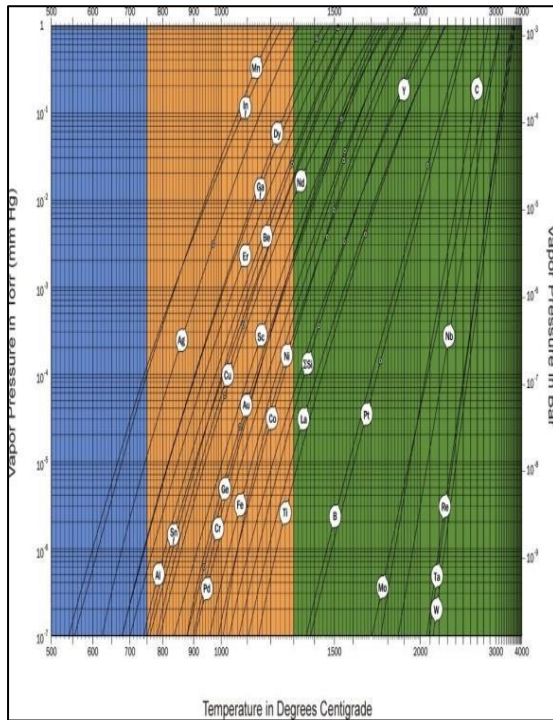

**5.0 Model Description**

General description of the model is presented in Fig ure 4 where pressure gas flow low in vacuum system i.e molecular flow and it can be seen that the model inputs are ambient temperature, evaporate temperature, vapor pressure, molecular weight, density of gold, neglecting the substrate surface temperature. The Free Molecular Flow interface uses the angular coefficient method to model flows with Knudsen numbers  $Kn > 10$ . This physics interface avoids solving the physics in the volumes of the modeled geometries, and requires meshing only of the surfaces. Completely diffuse scattering (total accommodation) and emission are assumed at all surfaces in the geometry, and flow is computed by integrating the flux arriving at a surface from all other surfaces in its line-of-sight. This means that the dependent variables exist only on the surfaces of the geometry, and the solution

process is much faster than the direct simulation monte carlo( DSMC) method. Furthermore, it is not subject to statistical scatter. Number densities are reconstructed using a method included in the free molecular flow interface. The Molecular flow module is designed to offer previously unavailable simulation capabilities for the accurate modeling of low pressure, low velocity gas flows in complex geometries. It is ideal for the simulation of vacuum systems including those used in semiconductor processing, particle accelerators and mass spectrometers. Small channel applications (e.g. shale gas exploration and flow in nanoporous materials) can also be addressed. The Molecular Flow Module uses a fast angular coefficient method to simulate steady-state free molecular flows. We can model isothermal and non-isothermal molecular flows, and automatically calculate the heat flux contribution from the gas molecules. The discrete velocity method is also included in the module for the simulation of transitional flows. Historically, flows in this regime have been modeled by the direct simulation monte carlo (DSMC) method. This computes the trajectories of large numbers of randomized particles through the system, but introduces statistical noise to the modeling process. For low velocity flows, such as those encountered in vacuum systems, the noise introduced by DSMC renders the simulations unfeasible. COMSOL uses alternative approaches: employing a discrete velocity method for transitional flows (using a Lattice Boltzmann velocity quadrature) and the angular coefficient method for molecular flows. Using the input parameters, the model computes the thickness of gold deposited, mass deposited on the surface of substrate, mass transfer rate and mass loss by using COMSOL software. The following wall conditions are inbuilt in COMSOL software:

- wall
- outgassing wall
- adsorption/desorption
- deposition

In adsorption/desorption boundry condition, sticking coefficient can be defined along with other condition. Gold, tin and indium is placed in resistively heated tungstun/molybdenum boat which is having very high melting point of 3420°C.

Substrate is one quarter of a 4" wafer mounted on stationary support on top of tungsten boat depending upon the mean free path and Langmuire-Kundsen relation. A screen is placed to cover the substrate, if more than one source is used.

**6.0 Results & Discussion**

In table 1 various input parameter required for the gold model are given to compute the molecular flow in vacuum system. Generally, the ambient temperature is fixed based on the experimental setup or experimental conditions but the evaporation temperature can be varied as per the thickness or mass transfer to be deposited on the substrate by considering the vapor pressure, to make fast the mass transfer keeping the good adhesion with uniformity on the substrate surface.

**Table 1: Input Parameter for the Gold Model**

Name	Expression	Value	Description
Tamb	293.15[K]	293.2 K	Ambient temperature
Tevap	1900[K]	1900 K	Evaporation temperature
pvap	100[Pa]	100.00 Pa	Vapor pressure of gold
Mn0	197[g/mol]	0.1970 kg/mol	Molecular weight of gold
Rho0	19.3 gc/m <sup>3</sup>	1.930E4 kg/m <sup>3</sup>	Density of Gold

**Fig 3: Molecular Flux After 60 Sec**

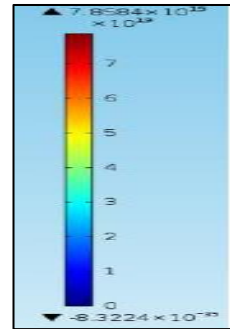
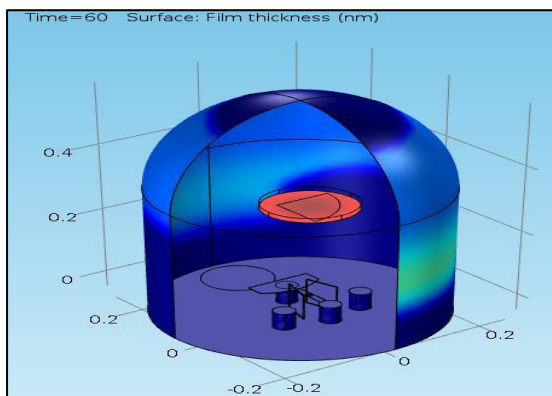

**Fig 4: Surface Film Thickness**

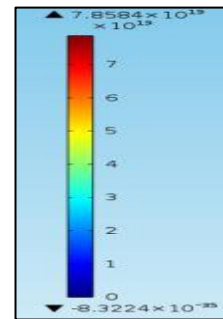
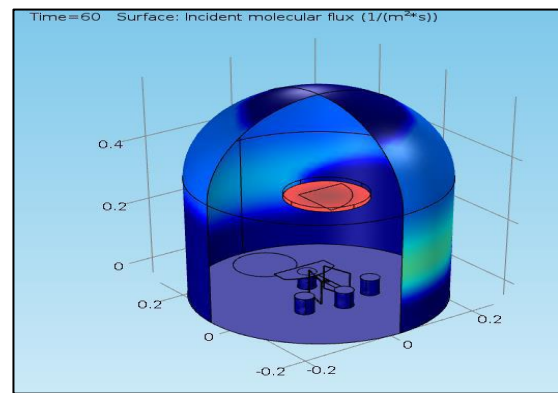

**Fig 5: Film Thickness Variation on Substrate Surface**

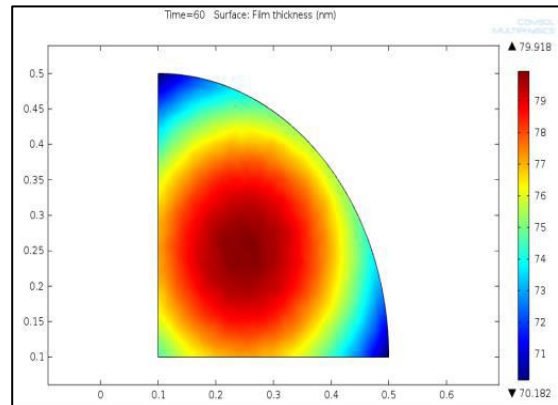
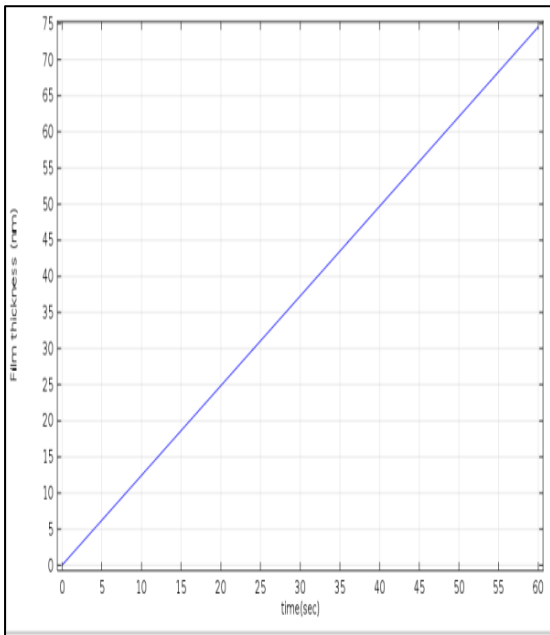
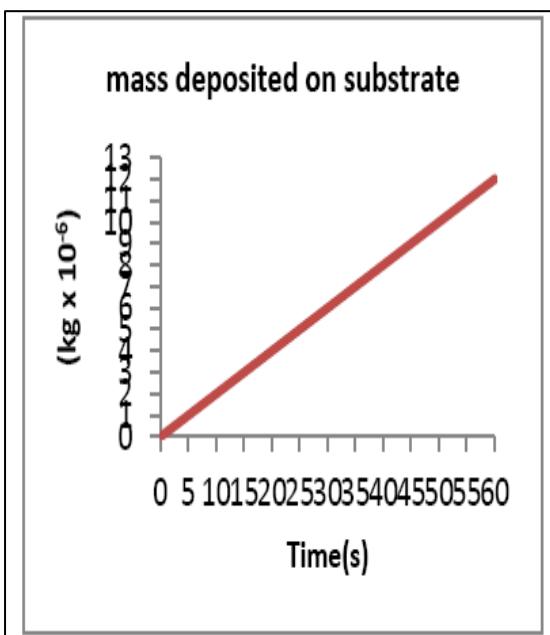

Figure 3 shows the flux of gold molecules on the surfaces of the model. This constant molecular flux  $7.858 \times 10^{19}$  ( $1/m^2s$ ) determines the thickness of gold deposited shown in Figure 4. In Figure 5, it is obvious the film

**Fig 6. Film Thickness After 60 Sec**



**Fig 7(a): Variation of Mass Deposited on Substrate with Time**



**Fig 7. Mass Transfer Rate in Kg/Sec**

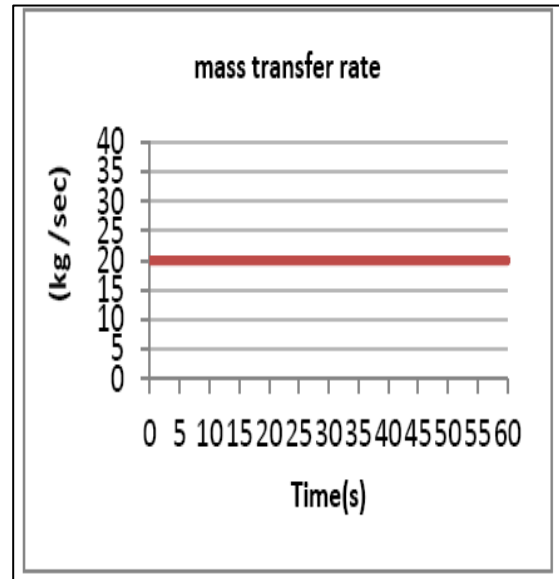

thickness is maximum in the centre of substrate positioned directly on vertically centre of tungsten boat/source, greater than 79.9 nm after 60 seconds of thermal evaporation process.

This thickness decreases radially outwards surface of the substrate 70 nm. In Figure 6, based on the molecular flux deposited on substrate, the graph shows the gold deposited thickness after 60 seconds from initial condition of zero second. It is clear from the graph that the film thickness varies linearly with time.

In Figure 7 graph is plotted with time for mass ( $kg \times 10^{-6}$ ) deposited on the surface of substrate and shows that as mass deposited on substrate is  $12 \times 10^{-6}$  which increases with time as in the case of Figure 8 since the depositing thickness with time adds mass also on the substrate.

In Figure 10 mass transfer rate ( $kg/sec \times 10^{-8}$ ) is plotted for 60 seconds and is a straight constant abscissa parallel line showing  $20 \times 10^{-8}$   $kg/sec$ .

Only the flux is required to compute the deposition rate, but in this instance, since most of the computational time is used to compute the view factors, solving the time dependent problem adds little additional time to the solution process. Using a time dependent model also allows for more advanced extensions of the model, for example, re-evaporation of gold from hot surface close to the

evaporative source could be included Figure 8. mass deposited on substrate surface

**Fig 8: SEM Micrograph of Gold at 50 KX Magnification**

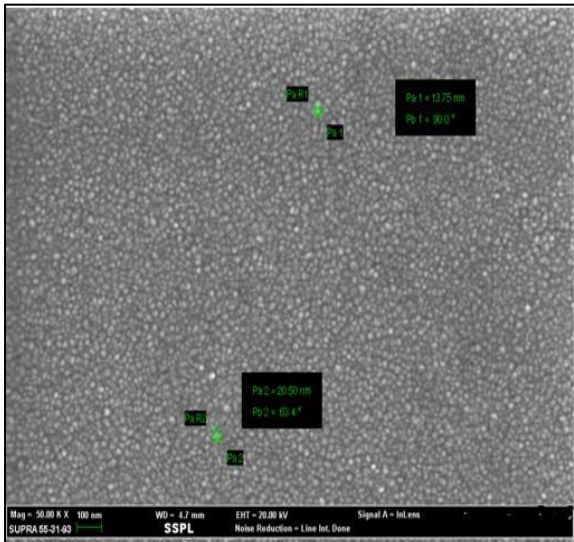

**Fig 9: SEM Micrograph of Gold at 100KX Magnification**

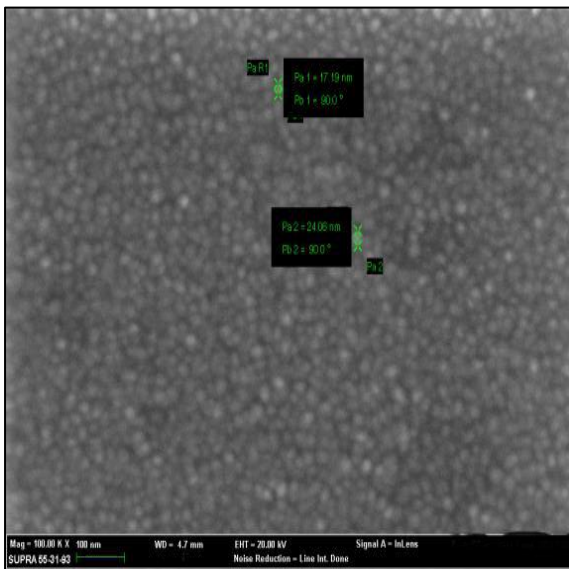
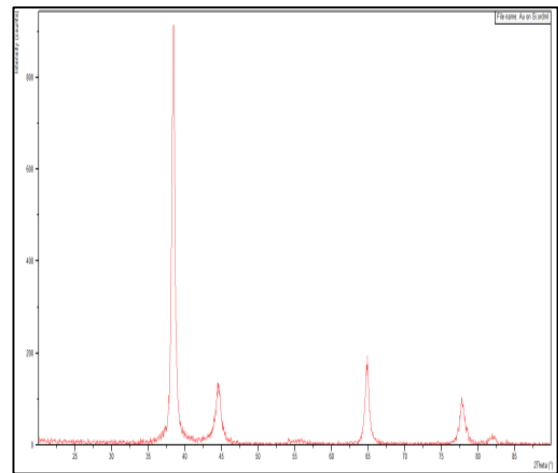

Figure 9 & 10 shows that gold SEM micrographs at 50KX & 100KX magnification which is very uniform and smooth and average grain size of gold is 15-30 nm across the grain boundary. Figure 11 shows the XRD analysis of

gold and shows the polycrystalline face centered cubic structure with preferential (111) plane.

Measurement of deposited film thickness for gold 800 Å from Dektak surface profiler & comparison with thickness value given by Digital thickness monitor (DTM), a piezoelectric transducer is shown in Figure 14. From the measurement results shows that in gold film thickness variation 5-15%. This variation in thickness is obvious since the locations of quartz crystal and substrate are different inside the vacuum chamber & this variation can be minimized by keeping them close together

**Fig 11: XRD Analysis of Gold on Silicon**



**Fig 12: Measurement of Gold Film Thickness at 6 Points by Dektak**

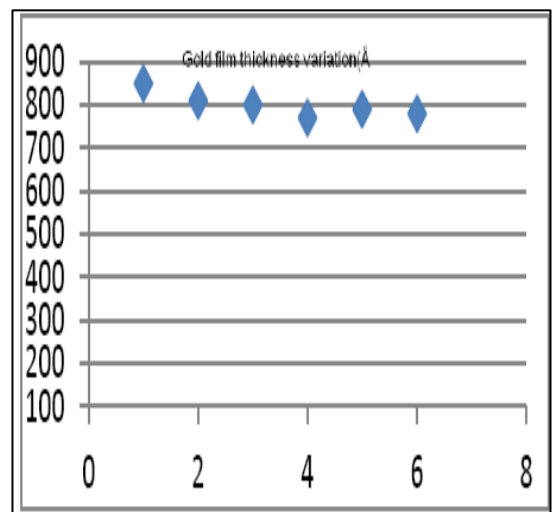



## 7.0 Conclusion

For Optimized methods for fast and accurate simulations, gases at low pressures cannot be modeled using conventional computational fluid dynamics tools or DSMC method. That is due to the fact that kinetic effects become important as the mean free path of the gas molecules becomes comparable to the length scale of the flow. Coatings of gold having good uniformity & appropriate thickness have been produced on stationary, non-rotated, flat substrates using a vacuum thermal evaporation technique that incorporates the use of a resistively heated tungsten/molybdenum boat. Thus this work presents the thermal evaporation of gold on silicon with thickness of 78-80 nm. The mass deposition of gold for 60 sec is  $12 \times 10^{-6}$  kg and mass transfer rate is  $20 \times 10^{-8}$  kg/sec. Gold is polycrystalline with fcc structure with preferential (111) plane. The average grain size is 15-30 nm with good, smooth and better dispersion on silicon. From above measurements it is concluded that variation in thickness in general is 5-15% from the value given by DTM ( piezoelectric transducer). This variation in thickness is obvious since the positions of substrate and quartz crystal are at different locations in the vacuum chamber.

## References

- [1] Ali Moarrefzadeh et.al., Simulation and Modeling of Physical Vapor Deposition (PVD) Process, Wseas Transactions on Applied and Theoretical Mechanics, 7(2), 2012
- [2] P. S. Raghupathi, Joseph George, C. S. Menon, The Effect of Deposition Rate on Electrical, Optical and Structural Properties of ITO Thin Films, E-Journal of Chemistry, 2(3), 2005, 171-177
- [3] Haichuan Mu, Hui Shen, David Klotzkin, Dependence of film morphology on deposition rate in ITO/TPD/Alq3/Al organic luminescence diode, Journal of Solid-State Electronics, 48, 2004, 2085–2088
- [4] Adeleh Granmayeh Rada, Hamed Abbasib, Mohammad Hossein Afzalib, Gold Nanoparticles: Synthesising, Characterizing and Reviewing Novel Application in Recent Years Physics Procedia, 22, 2011, 203 – 208
- [5] Ragini Raj Singh, et.al, Investigation of passivation processes for HgCdTe/CdS structure for infrared application, 10, 2006, 235–240
- [6] Wenjun Zhou et al. , Effective Permittivity of Ultrathin Chemical Vapor Deposited Gold Films on Optical Fibers at Infrared Wavelengths, J. Phys. Chem. C, 118, 2014, 670–678
- [7] Keewah Chan et al., Formation of gold nanoparticles in silicon suboxide films prepared by plasma enhanced chemical vapour deposition, journal of thin solid films, 519, 2011, 4952-4957
- [8] Carl E. Larson et al., Chemical Vapor deposition of Gold, IBM Almaden Research Center, San Jose, California 95120, 1986
- [9] Miroslav Gojo et al., Electrochemical Deposition of Gold in Citrate Solution Containing Thallium Polja-eka, Acta Chim. Slov. 2008, 55, 330–337
- [10] Anne-Felicie Lamic-Humblot, et.al, An easy way to obtain thin film on silica glass substrate by chemical method, 539, 2013, 151–153
- [11] T. Donnelly, S. Krishnamurthy, K. Carney, N. McEvoy, J. G. Lunney, Pulsed laser deposition of Nanoparticles of film Au, Journal of Applied Surface Science, 254, 2007, 1303–1306
- [12] X. Zhang, X. Zhang, S. S. Chu, J. R. Ho, C. P. Grigoropoulos, Excimer laser

- ablation of thin gold films on a quartz crystal microbalance at various ambient background pressures, *Journal of applied physics A*, 64, 1997, 545-552
- [13] Anna Schaub, Petr Slepicka, Irena Kasparkova, Petr Malinsky, Gold Nanolayer and Nanocluster coatings induced by heat treatment and evaporation technique, *Springer Open Journal, Nanoscale Research letters* 2013, 8, 249
- [14] Behrang Moazzez, Stacey M. O'Brien and Erika F. Merschrod S., Improved Adhesion of Gold Thin Films Evaporated on Polymer Resin: Applications for Sensing Surfaces and MEMS, *Journal of Sensors*, 13, 2013, 7021-7032
- [15] Maxime Gougis, Antonio Pereira, Dongling Ma and Mohamed Mohamedi, Oxygen Gas Assisted Laser Deposition of Gold Thin Films: Electrooxidation of Glucose, *International Journal of Electrochemical Science*, 9, 2014, 3588-3601
- [16] C. Celedón, M. Flores, P. Haberle, J. E. Valdés, Surface Roughness of Thin Gold Films and its Effects on the Proton Energy Loss Straggling, *Brazilian Journal of Physics*, 36(3B), 2006, 956-959
- [17] Hartmann Hieber, Karin Pape, Ageing of Thin Gold Films, *Gold Bull.*, 1982, 15, (3)
- [18] Adam Proszkynski, Dariusz Chocyk, Grzegorz Gladyszewski, Stress modification in gold metal thin films during thermal annealing, *Optica Applicata*, XXXIX(4), 2009, 705-710
- [19] Author K.Burak Ucer, Vacuum evaporation, [www.users.wfu.edu](http://www.users.wfu.edu)